

11.1.1 TECHNICAL DATA

MAX OPERATING PRESSURE (PS): 600 BAR

PRESSURE TEST (PT): 1.43 x PS

SCALE OF PRESSURE GAUGE:

4 - 10 - 16 - 25 - 60 - 100 - 250 (std.) - 400 - 600 bar

WORKING TEMPERATURE: - 20 ÷ +80°C

MEDIUM: Nitrogen

NITROGEN CONTAMINATION DEGREE:

class 20/18/15 according to ISO 4406/99

BODY MATERIAL: phosphated carbon steel or galvanized carbon steel in compliance with Directive 2002/95/EC (RoHS) to resist to corrosion

SEALS MATERIAL: P = Nitrile rubber (NBR) and Delrin

FILLING VALVE CONNECTION: 5/8" UNF + adapters (upon request)

WEIGHT: 1.8 Kg. (complete with case)

11.1.2 DESCRIPTION

The charging and gauging assembly consists of 3 mt. charging hose with standard nitrogen nipples, body incorporating gas valve connection, bleed valve and check valve. These kits are packed in a plastic storage case. Gauge is diameter 63 mm. diam type pressure gauges with 0÷250 bar graduation. The following charging kit are recommended to be used on all piston accumulators (with standard filling valves V or VX), on all bladder accumulators, on screwed and forged diaphragm accumulators. It is used for the periodic check of accumulator pre-charge and for the inflation of accumulators after the maintenance or it is used for the change of pre-charge value. For the inflation, it is necessary a connection to a bottle filled with industrial dry nitrogen with a pressure higher than the pre-charge value required, provided with pressure reducer (mandatory, for safety reasons, during the inflation of accumulators with PS < 210 bar).

Furthermore, the use of a pressure reducer makes easier the slow and graduated inflow of nitrogen on the bladder, thus avoiding the possibility of damaging the bladder itself.

NOTE: These assemblies are not recommended for continuous monitoring of gas pre-charge. For continuous monitoring, see Gas Adapters at Section 8.3



11.1a

11.1.3 HYDRAULIC SYMBOL

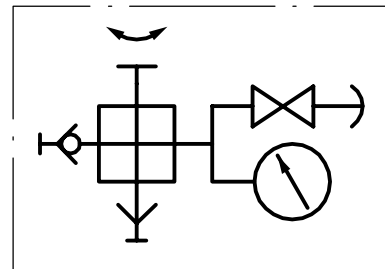

11.1b

11.1.4 CONSTRUCTION

STANDARD VERSION includes:

- Valve body complete with ring nut connection to accumulator gas valve, pressure gauge, bleed and non return snap-in hose connection.
- 3 mt charging hose for high pressure series complete with bottle connection.
- Set of spare gaskets.
- Case.

UPON REQUEST:

- Nipple for to pressure reducer.
- ADAPTERS for special accumulator gas valves.
- CHARGING HOSE with length of 1 - 4 - 6 mt.

11.1.5 ORDER CODE

1	2	3	4	5
PC	250	S	1	-

1	Series
	Pre-loading and checking = PC

2	Scale of pressure gauge (bar)
	0 ÷ 4 = 4
	0 ÷ 10 = 10
	0 ÷ 16 = 16
	0 ÷ 25 = 25
	0 ÷ 60 = 60
	0 ÷ 100 = 100
	0 ÷ 250 = 250 (standard)
	0 ÷ 400 = 400
	0 ÷ 600 = 600

3	Filling valve connection
	5/8" UNF = S (standard)
	VG8 (Ø 7.7 x 1/32") = A
	7/8" UNF = B
	1/4" BSP ISO 228 = C
	VG8 (Ø 7.7 x 1/32") long thread = D
	7/8" UNF with pin = E

5	Charging hose (meters)
	Standard 3 mt = -
	1 mt = C
	4 mt = M
	6 mt = L

4		Connection to bottle (according to Country standards)
Italy	= 1	Indonesia
Austria	= 2	Ireland
Czech Republic		Jamaica
Denmark		Kenya
Finland		Malaysia
Germany		Malta
Netherlands		New Zealand
Norway		Pakistan
Poland		Portugal
Sweden		Singapore
Switzerland		Sri Lanka
Belgium	= 3	Sudan
Algeria		Tanzania
Bahrain		Thailand
Bulgaria		Turkey
Egypt		Vietnam
France		Zambia
Gabon	= 5	Brazil
Guinea		Puerto Rico
Hungary	= 6	South Africa
Iran		Philippines
Iraq		Australia
Israel	= 7	Canada
Ivory Coast		U.S.A.
Jordan	= 8	Albania
Kuwait		Russia
Libya		Venezuela
Mauritius	= 9	Japan
Mexico	= 10	Taiwan
Morocco	= 11	China
Mozambique	= 12	Korea
Nigeria	= 13	Bolivia
Oman		Chile
Qatar		Colombia
Romania		Dominican Republic
Saudi Arabia		Ecuador
Slovenia		Guatemala
Spain		Guyana
Syria		Honduras
Tunisia		Paraguay
United Arab Emirates		Peru
Argentina	= 4	Uruguay
Bahamas		
Barbados		
Costa Rica		
Cyprus		
Ethiopia		
Gambia		
Ghana		
Great Britain		
Greece		
Hong Kong		
India		

Special variants on request

11.1.6 DIMENSIONS

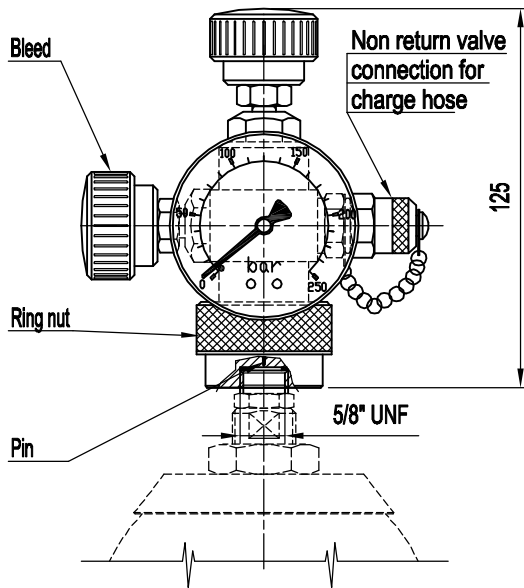

11.1c

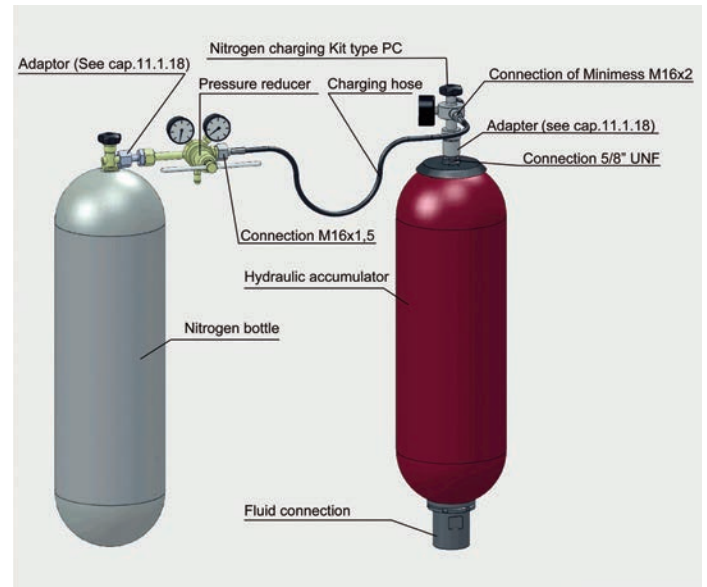

11.1d

11.1.7 SPARE PARTS CODE

Spare parts	number code
Complete PC body with manometer	B2156/*
PC body without manometer	B2157
Manometer	B2163/*
Flexible hose of 1 meter	B2166/1
Flexible hose of 3 meters (standard)	B2166/3
Flexible hose of 4 meter	B2166/4
Flexible hose of 6 meter	B2166/6
Complete central pin	B2165
Complete bleed	B2164
Non return valve	B2162
Seals kit	B2160/**
Seal face for filling valve	B10342 D

* = see scale of pressure gauge at Section 11.1.4

** = see table 11.1h for country codes

11.1d

11.1.8 ACCESSORIES

Adapters

All adapters represented below serve to use the EPE pre-charge equipment on the accumulators of the main international manufacturers.

Type "A"

Adapter B2510

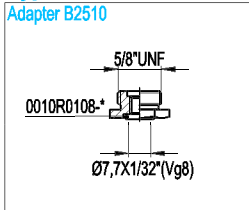

Type "B"

Adapter B2511

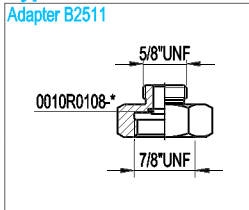

Type "C"

Adapter B2512

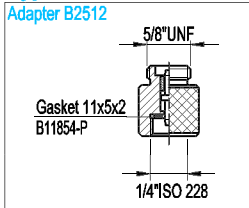

Type "D"

Adapter B2513

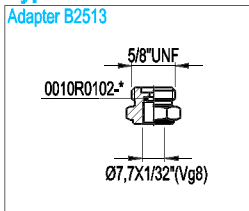

Type "E"

Adapter B2514

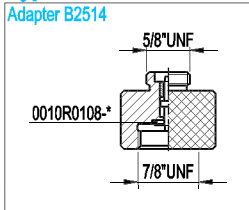

11.1e

Connection nipple for pressure reducer

The use of pre-charging equipment for the inflation of "low pressure" accumulators requires, for safety reasons, a pressure reducer (see Section 11.3) mounted on the nitrogen bottle, which is calibrated according to a pressure equal or lower than the maximum PS operating pressure, stamped on the accumulator shell.

The fitting nipple between the charging hose and the pressure reducer must be ordered separately with code 11447.

Nipple No. B2515

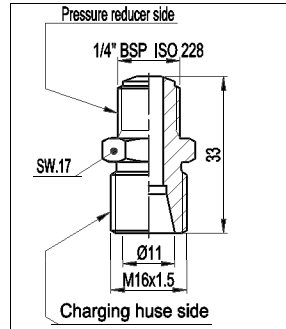

for pressure reducer see chapter 11.3

11.1f

Connection nipple for nitrogen cylinder

For "high pressure" accumulators and for all models with PS ≥ 210 bar, you can connect to the nitrogen bottle through the proper fitting without the use of the pressure reducer.

The suitable nipple must be chosen according to the Country of origin of the nitrogen bottle, as shown in the side Table.

The no. of the column marked by the x indicates the figure of the nipple valid for that Country and coincides with the number used to indicate the bottle connection in the designation code of the complete equipment (Chapter 11.1.4).

Each nipple has its own code (in brackets) to be used for ordering spare parts and not indicated in the designation of the pre-charging equipment.

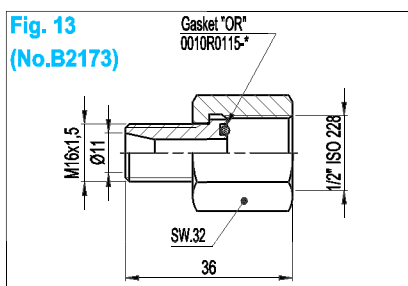
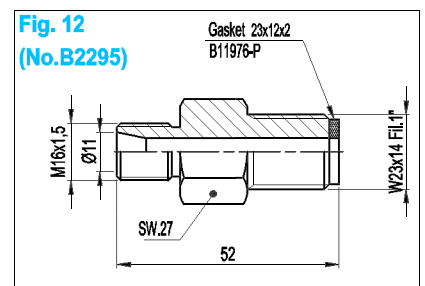
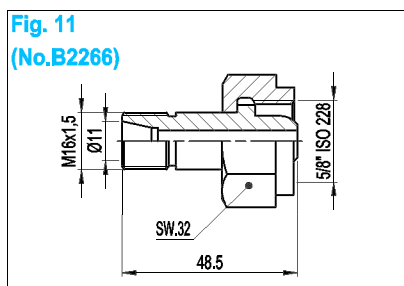
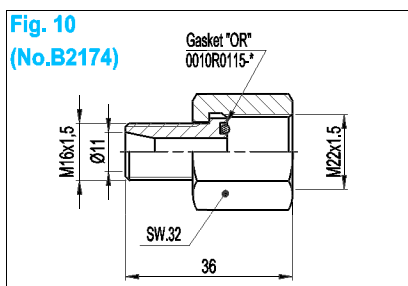
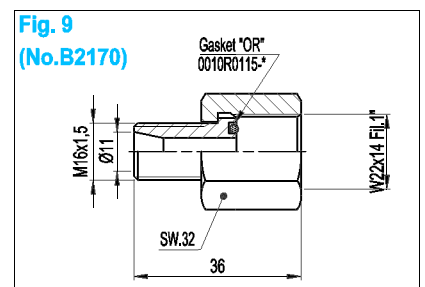
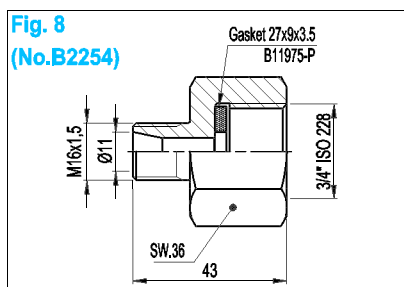
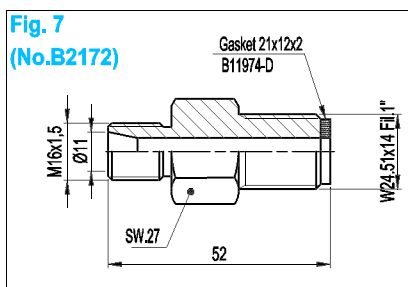
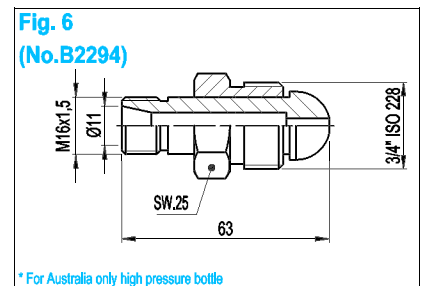
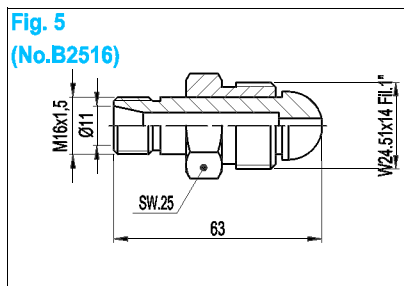
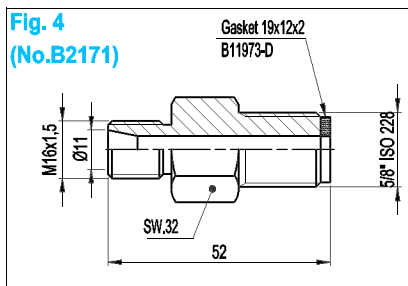
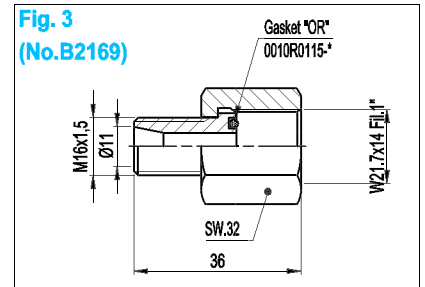
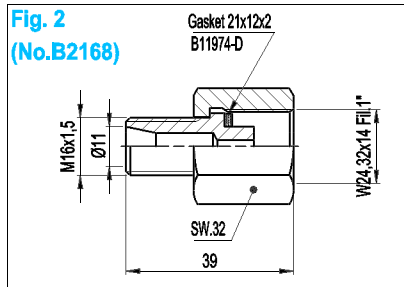
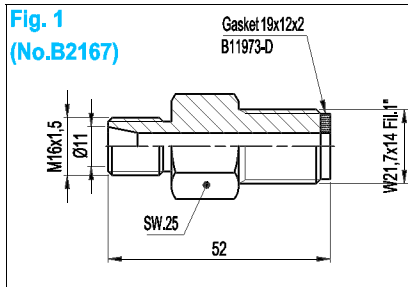

Country	Type / part code												
	1	2	3	4	5	6	7	8	9	10	11	12	13
Albania								X					
Algeria			X										
Argentina				X									
Australia						X							
Austria		X											
Bahamas				X									
Bahrain			X										
Barbados				X									
Belgium			X										
Bolivia													X
Brazil					X								
Bulgaria			X	X									
Canada							X						
Chile													X
China											X		
Colombia													X
Costa Rica				X									
Cyprus				X									
Czech Republic		X											
Denmark		X											
Dominican Republic													X
Ecuador													X
Egypt			X										
Ethiopia				X									
Finland		X											
France			X										
Gabon			X										
Gambia				X									
Germany		X											
Ghana				X									
Great Britain				X									
Greece				X									
Guatemala													X
Guinea			X										
Guyana													X
Honduras													X
Hong Kong				X									
Hungary			X										
India				X									
Indonesia				X									
Iran			X										
Iraq			X										
Ireland				X									
Israel			X										
Italy	X												
Ivory Coast			X										
Jamaica				X									
Japan									X				

Country	Type / part code												
	1	2	3	4	5	6	7	8	9	10	11	12	13
Jordan			X										
Kenya				X									
Korea												X	
Kuwait			X										
Libya			X										
Malaysia				X									
Malta				X									
Mauritius			X										
Mexico			X										
Morocco			X										
Mozambique			X										
Netherlands		X											
New Zealand				X									
Nigeria			X										
Norway		X											
Oman			X										
Pakistan				X									
Paraguay													X
Perù													X
Philippines						X							
Poland		X											
Portugal				X									
Puerto Rico					X								
Qatar			X										
Romania			X										
Russia								X					
Saudi Arabia			X										
Singapore				X									
Slovenia			X										
South Africa						X							
Spain			X										
Sri Lanka				X									
Sudan				X									
Sweden		X											
Switzerland		X											
Syria			X										
Taiwan										X			
Tanzania				X									
Thailand				X									
Tunisia			X										
Turkey				X									
United Arab Emirates			X										
Uruguay													X
U.S.A.							X						
Venezuela								X					
Vietnam				X									
Zambia				X									

11.1.9 COMMISSIONING AND MAINTENANCE

General

For proper operation of the accumulator, it is necessary to maintain a constant pre-charge pressure, which should be checked periodically using the **pre-charge and checking set type PC250**.

The same equipment is also used to inflate the accumulator (after a repair, for a change of use, etc.) connecting it with the appropriate charging hose to a dry nitrogen bottle equipped with pressure reducer (see Section 11.3), so that the nitrogen enters the accumulator very slowly to avoid possible breakage of the bladder or the diaphragm and to limit the temperature change.

In fact, the process of charging or discharging an accumulator with nitrogen causes a temperature change which is transmitted to the surrounding air until the temperature of the accumulator stabilizes.

For the effects of temperature transfer, the accumulator should be allowed to stand for a minimum of 60 minutes before a final reading of the pre-charge pressure is taken.

Checking the pre-charge

Before proceeding, it is necessary to isolate the accumulator from the system and discharge completely the fluid under pressure.

Remove the cap of the gas valve and the cap of the filling valve.

Before mounting the PC250 equipment, make sure that the knob **A** is **unscrewed**, that the bleed **B** is **closed**, that the check valve **C** has its **cap screwed** and that the pressure gauge has mounted a full scale appropriate to the pressure to read (normally the pressure to be read must not exceed the 3/4 of full scale).

Tighten by hand, using the knurled nut **D**, the charging set on the gas valve.

Screw, without forcing, the knob **A** to read the pressure on the gauge.

If the value corresponds to the one required, you can proceed to unscrew the knob **A** until it stops, but without forcing, open the bleed **B** and disassemble the equipment by unscrewing the nut **D**.

Decreasing the pre-charge

If the pre-charge value is **greater** than the one required, you should discharge the exceeding pressure by acting on the bleed **B** until reaching the desired value.

We suggest **discharging slowly** and then carrying out the final reading after at least 15 minutes from the discharge operation. Then you can remove the equipment as above indicated.

Increasing or restoring the pre-charge

If the pre-charge is less than the established value (or if it is necessary to re-inflate the accumulator after a repair), proceed as follows (place the equipment as indicated in the Section "Checking the pre-charge"):

- Mount the nipple to the nitrogen bottle or to the pressure reducer.
- Connect the hose extremity to the nipple.
- Connect the other hose extremity to the check valve **C** after having removed its cap.
- Open **slowly** the shut-off valve of the nitrogen bottle or the knob of the pressure reducer and keep it open until it reaches a pressure slightly higher than the required value (+ 10 ÷ 15%), then **close** the valve.
- **Unscrew** the knob **A** and decompress the equipment with the bleed valve **B**.
- Disconnect the charging hose of the check valve **C**.
- **Close** the bleed valve, place the **cap** to the check valve **C** and wait at least 15 minutes for the pressure stabilization.
- **Screw** again the knob **A** until reading the pressure that should be slightly higher than requested. Adjust the pre-charge value, using the bleed valve, and disassemble the equipment, as already indicated.
- Check with soapy water that there are no leaks coming out from the filling valve of the accumulator.
- Screw the cap of the filling valve and the external protection cap.

Now the accumulator is ready for commissioning.

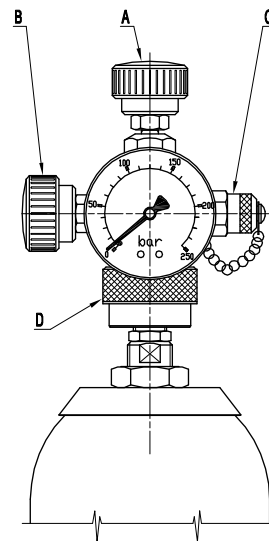

11.1i

Reproduction is forbidden.

In the spirit of continuous improvement, our products may be changed.